

SERIE 102 ref. 102 3 / 102 5 / 102 5 1 / 102 7

Caja de herramientas con 3 compartimentos y divisiones.
Caisse à outils avec 3 compartiments et séparateurs.
Toolbox with 3 compartments and divisions.

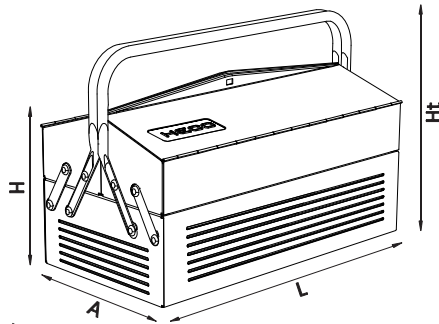

e 0.6 mm



SERIE 102 3 STANDARD

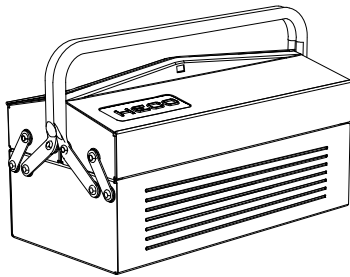

e 8.2 m³

	102 3	9,2 Kg		L x A x H	Ht
	accesorios / accessoires / accessories				
3	102 3 01			330 x 175 x 140	210
-				candado / cadenas / padlock Ø 7mm	

SERIE 102 5 1 STANDARD

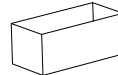

CPA 06

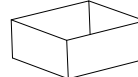

CPA 07

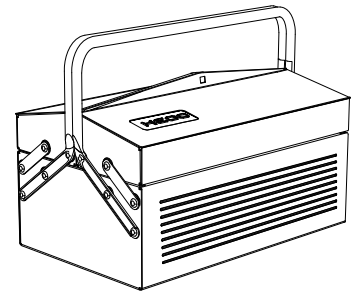

e 14.9 m³

	102 5 1	17 Kg		L x A x H	Ht
	accesorios / accessoires / accessories				
3	102 7 01			400 x 245 x 230	310
1	CP A 06			cubeta / boîte / tray 120x60x50	
1	CP A 07			cubeta / boîte / tray 120x120x50	
-				candado / cadenas / padlock Ø 7mm	

SERIE 102 5 STANDARD

200 2 02

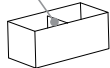

CP A 00



CPA 02

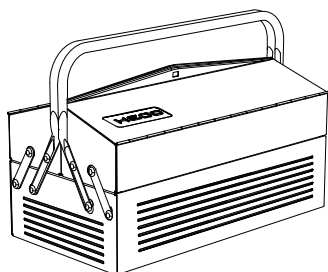

e 15.5 m³

	102 5	14 Kg		L x A x H	Ht
	accesorios / accessoires / accessories				
1	102 5 01			400 x 210 x 195	275
1	CP A 00			cubeta / boîte / tray 100x50x50	
1	200 2 02			división cubeta plástico/séparation boîte plastique/plastic division tray	
1	CP A 02			cubeta / boîte / tray 100x100x50	
-				candado / cadenas / padlock Ø 7mm	

SERIE 102 7 STANDARD



CPA 06



CPA 07

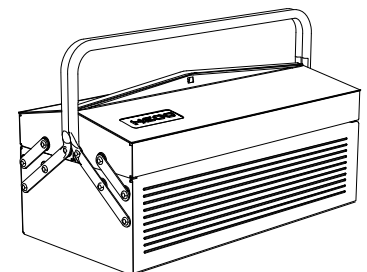

e 24.4 m³

	102 7	21,5 Kg		L x A x H	Ht
	accesorios / accessoires / accessories				
1	102 7 01			485 x 245 x 230	310
1	CP A 06			cubeta / boîte / tray 120x60x50	
1	CP A 07			cubeta / boîte / tray 120x120x50	
-				candado / cadenas / padlock Ø 7mm	